

UTS SALES AND REPAIRS

A SAFER WAY TO REACH NEW HEIGHTS

Narrow Tower 1.5m Long x 0.5m Wide	Working Height 3.7m	Platform Height 1.7m
--	-------------------------------	--------------------------------

Tower Components

Item	Description	Quantity
1	Adjustable Leg and Fixed Base Plate	4
2	1.75m,0.5m Walkthrough Frame	1
3	1.75m,0.5m Walkthrough Frame with Ladder	1
4	1.0m,0.5m 4 Rung Frame	2
5	1.5m,0.5m 6 Rung Frame	0
6	2.0m,0.5m 8 Rung Frame	0
7	1.5m,0.5m Trapdoor Platform	1
8	1.5m Upper Brace Frame	2
9	1.5m Base Brace Frame	2
10	1.5m,0.5m Toeboard Set	1
11	Wall Prop	2
12	Instruction Manual	1

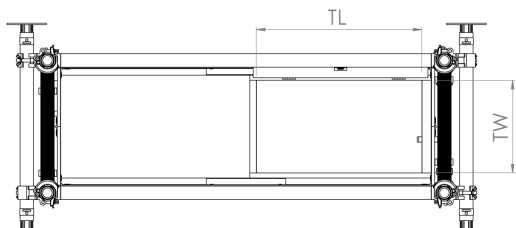
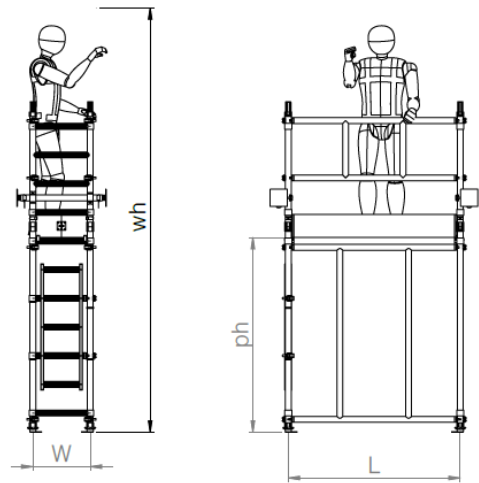
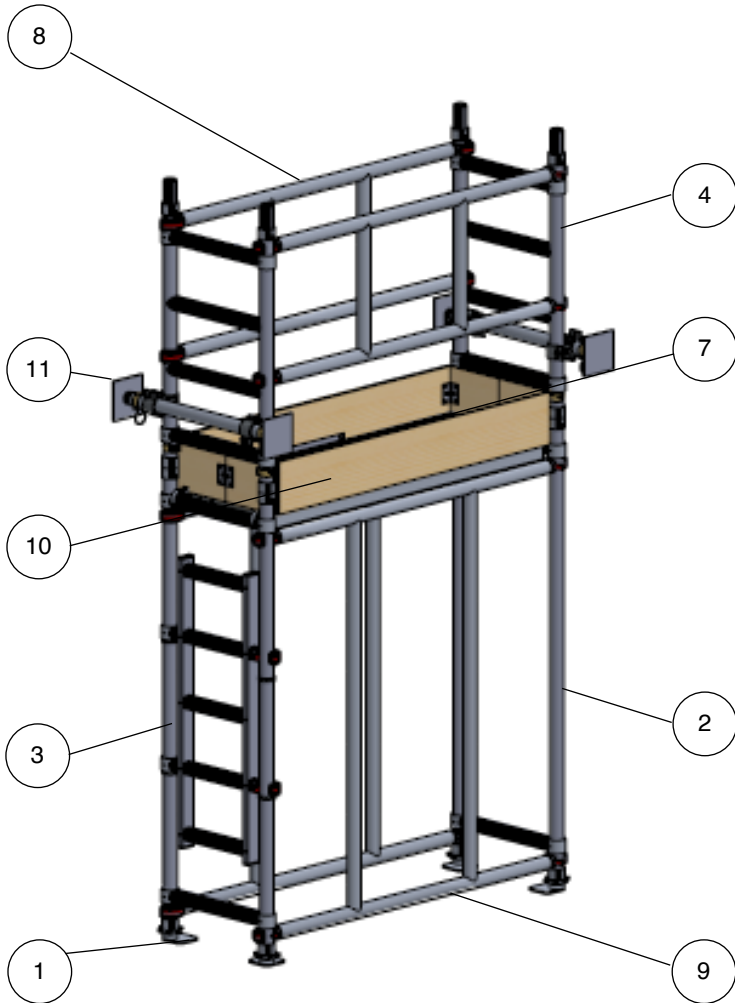

Technical information:

Base Dimensions:	(L)1.5m X (W)0.5m
Maximum Platform Height (ph):	1.7m
Maximum Working Height (wh):	3.7m
Trap Opening Length (TL)	625mm
Trap Opening Width (TW)	350mm
Maximum Working Load Per Platform:	275kg
Maximum Working Load Per Tower: (including tower weight)	550kg
Weight:	89.5kg

01227 860085
Mon-Fri, 8am until 5pm

For More Information:
info@towersandpodiums.co.uk
We reply within 1 hour
Mon-Fri, 8am until 5pm

